

料表编号：16102816



浙江昆仑建设集团

项目名称： 荆州一医地下室

构件部位： 基础_塔楼A_承台

相同层数：1

序号	分类	Φ8	Φ10	Φ12	Φ14	Φ18	Φ20	Φ25	Φ28	Φ32	合计
1	重量	431	92	4207	5293	18975	1029	37557	85236	16063	108.883
2	正丝					17		98	825	98	1038
3	反丝					20			37		57
4	搭接			136							136

注：重量单位明细为公斤、合计为吨；接头单位为个。

日期：2017年02月19日





钢筋配料表

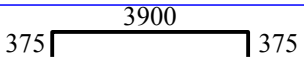
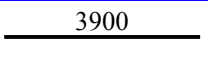
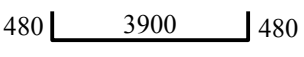

料单编号:16102816

项目名称: 荆州一医地下室

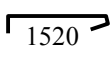
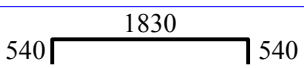
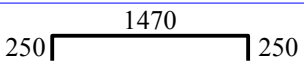
部位: 基础_塔楼A_承台

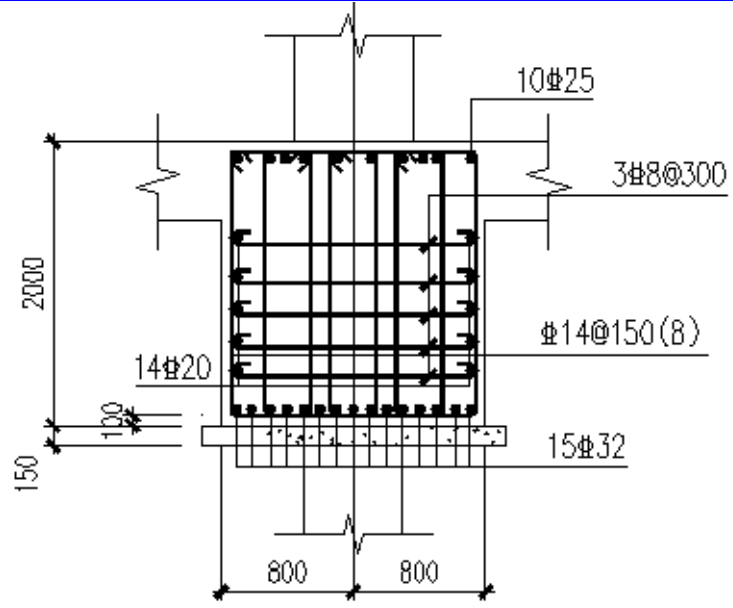
构件名称	级直别径	钢筋简图	下料 (mm)	根件数*数	总根数	备注
CT2a	Φ25	375  375	4550	10*5	50	面筋
	Φ20	 3900	3900	14*5	70	腰筋
	Φ32	480  480	4730	15*5	75	底筋
	Φ14	 1870	7030	27*5	135	@150
	Φ14	 1870	4770	81*5	405	套3根
	Φ8	 1520	1680	84*5	420	@300
	Φ18	540  540	2840	12*5	60	封边竖向@200
	Φ12	250  250	1920	14*5	70	封边水平@200

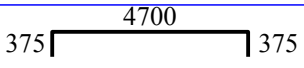
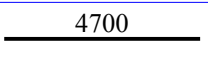
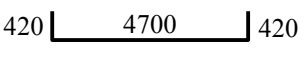

CT2b	Φ25	375  375	5350	10*2	20	面筋
	Φ20	 4700	4700	14*2	28	腰筋
	Φ28	420  420	5430	15*2	30	底筋
	Φ14	 1870	7030	32*2	64	@150

审核:

翻样: 秦黄海 13574434596 第1页,共35页 2017/2/19 星期日 9:57



钢筋配料表

料单编号:16102816

项目名称: 荆州一医地下室

部位: 基础_塔楼A_承台

构件名称	级直别径	钢筋简图	下料 (mm)	根件数*数	总根数	备注
	Φ14	1870	4770	96*2	192	套3根
	Φ8	1520	1680	105*2	210	@300
	Φ18	1830 540 540	2840	12*2	24	封边竖向@200
	Φ12	1470 250 250	1920	14*2	28	封边水平@200

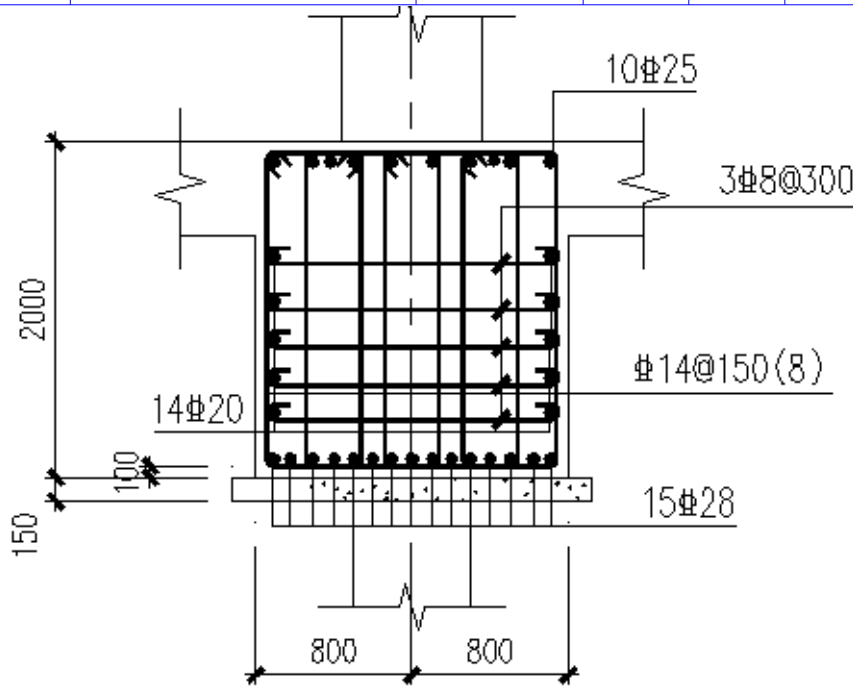

以下为CT3a料单, 绑扎详图另出

CT3a 1#筋	Φ25	3900 250 250	4300	9*3	27	布置于等腰底部@120
CT3a 2#筋	Φ25	3770 250 250	4170	3*3	9	布置于等腰底部@120
	Φ25	3220 250 250	3620	3*3	9	@120
	Φ25	3630 250 250	4030	3*3	9	@120
	Φ25	3355 250 250	3755	3*3	9	@120
	Φ25	3495 250 250	3895	3*3	9	@120
CT3a 3#筋	Φ25	3945 250 250	4345	6*3	18	布置与承台等腰两侧@120

审核:

翻样: 秦黄海 13574434596 第2页,共35页 2017/2/19 星期日 9:57



钢筋配料表

料单编号:16102816

项目名称: 荆州一医地下室

部位: 基础_塔楼A_承台

构件名称	级直别径	钢筋简图	下料(mm)	根件数*数	总根数	备注
	Φ25		4070	6*3	18	@120
	Φ25		3790	6*3	18	@120
	Φ25		3510	6*3	18	@120
CT3a 4#筋	Φ25		4565	18*3	54	布置与承台等腰两侧 @120
CT3a 5#筋	Φ25		4325	6*3	18	布置与承台等腰两侧 @120
	Φ25		3765	6*3	18	@120
	Φ25		4185	6*3	18	@120
	Φ25		3905	6*3	18	@120
	Φ25		4460	6*3	18	@120
	Φ25		4045	6*3	18	@120
CT3a 6#分布筋	Φ10		1440	6*3	18	布置与承台等腰底部 @200
CT3a 7#分布筋	Φ10		1440	14*3	42	布置与承台等腰两侧 @200
	Φ18		2790	56*3	168	封边竖向@200
	Φ12		1290	7*3	21	1#封边水平@200
	Φ12		3490	14*3	42	2#封边水平@200
	Φ12		1370	14*3	42	3#封边水平@200
	Φ12		4270	7*3	21	4#封边水平@200
以下为CT3b料单, 绑扎大样图另出						
CT3b 1#底筋	Φ25		4300	9*2	18	布置于等腰底部@120
CT3b 2#底筋	Φ25		4170	1*2	2	布置于等腰底部@120

审核:

翻样: 秦黄海 13574434596 第3页,共35页 2017/2/19 星期日 9:57



钢筋配料表

料单编号:16102816

项目名称: 荆州一医地下室

部位: 基础_塔楼A_承台

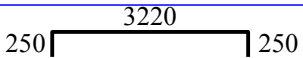
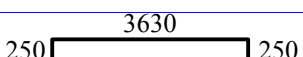
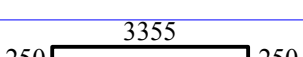
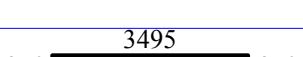
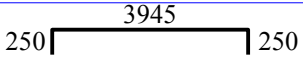
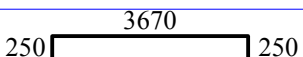
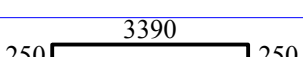
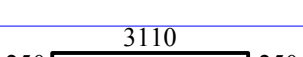
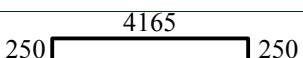
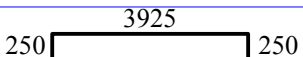
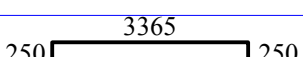
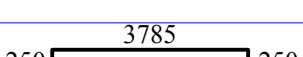
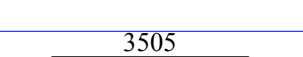
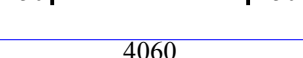
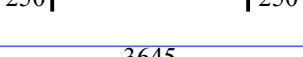
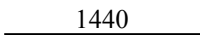
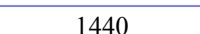
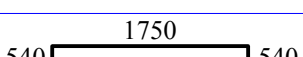
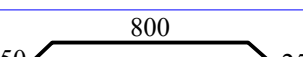
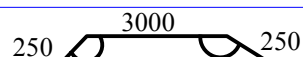
构件名称	级直别径	钢筋简图	下料 (mm)	根件 数*数	总 根数	备 注
	Φ25	250  250	3620	1*2	2	@120
	Φ25	250  250	4030	1*2	2	@120
	Φ25	250  250	3755	1*2	2	@120
	Φ25	250  250	3895	1*2	2	@120
CT3b 3#底筋	Φ25	250  250	4345	2*2	4	布置与承台等腰两侧 @120
	Φ25	250  250	4070	2*2	4	@120
	Φ25	250  250	3790	2*2	4	@120
	Φ25	250  250	3510	2*2	4	@120
CT3b 4#底筋	Φ25	250  250	4565	6*2	12	布置与承台等腰两侧 @120
CT3b 5#底筋	Φ25	250  250	4325	2*2	4	布置与承台等腰两侧 @120
	Φ25	250  250	3765	2*2	4	@120
	Φ25	250  250	4185	2*2	4	@120
	Φ25	250  250	3905	2*2	4	@120
	Φ25	250  250	4460	2*2	4	@120
	Φ25	250  250	4045	2*2	4	@120
CT3b 6#分布筋	Φ10	 1440	1440	6*2	12	@200
CT3b 7#分布筋	Φ10	 1440	1440	14*2	28	布置与承台等腰两侧 @200
	Φ18	540  540	2760	56*2	112	封边竖向@200
	Φ12	250  250	1290	7*2	14	1#封边水平@200
	Φ12	250  250	3490	14*2	28	2#封边水平@200

审核:

翻样: 秦黄海 13574434596 第4页,共35页 2017/2/19 星期日 9:57





钢筋配料表

料单编号:16102816

项目名称: 荆州一医地下室

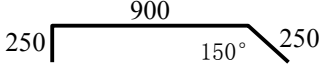
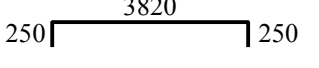
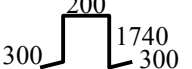
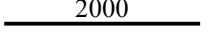
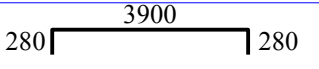
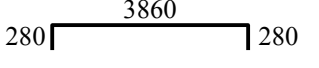
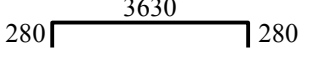
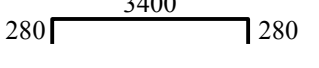
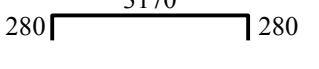
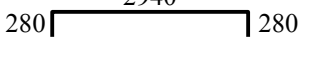
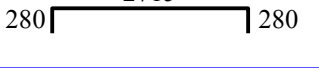
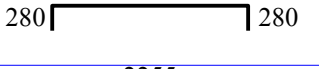
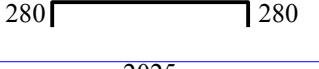
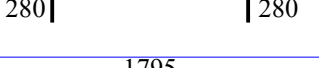
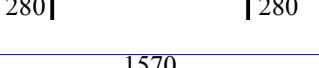
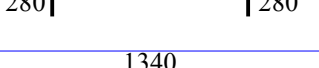
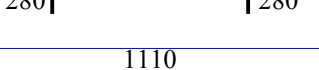
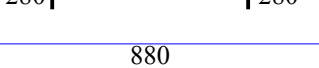
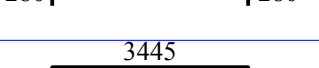
部位: 基础_塔楼A_承台

构件名称	级直别径	钢筋简图	下料 (mm)	根件 数*数	总 根数	备 注
	Φ12		1370	14*2	28	3#封边水平@200
	Φ12		4270	7*2	14	4#封边水平@200
	Φ25		4080	10*2	20	马镫每平方1个
	Φ25		2000	20*2	40	斜向拉撑每个马镫2个
CT3b 8#面筋	Φ28		4350	5*2	10	X向, @200
CT3b 9#面筋	Φ28		4305	1*2	2	X向, @200
	Φ28		4080	1*2	2	@200
	Φ28		3850	1*2	2	@200
	Φ28		3620	1*2	2	@200
	Φ28		3390	1*2	2	@200
	Φ28		3160	1*2	2	@200
	CT3b 10#面筋	Φ28		2930	1*2	2
Φ28			2705	1*2	2	@200
Φ28			2475	1*2	2	@200
Φ28			2245	1*2	2	@200
Φ28			2015	1*2	2	@200
Φ28			1785	1*2	2	@200
Φ28			1560	1*2	2	@200
Φ28			1330	1*2	2	@200
CT3b 11#面筋		Φ28		3895	1*2	2

审核:

翻样: 秦黄海 13574434596 第5页,共35页 2017/2/19 星期日 9:57





钢筋配料表

料单编号:16102816

项目名称: 荆州一医地下室

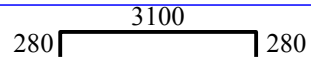
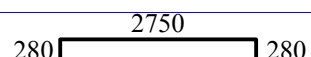
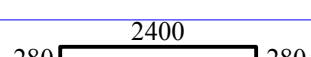
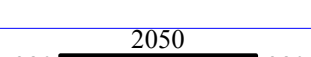
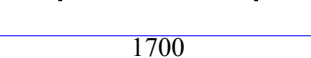
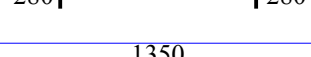
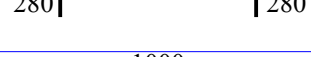
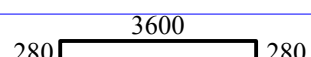
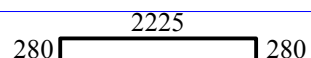
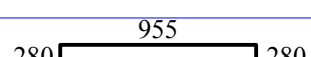
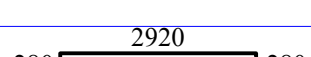
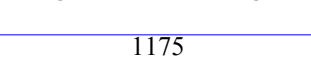
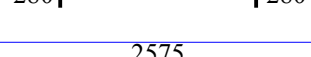
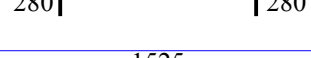
部位: 基础_塔楼A_承台

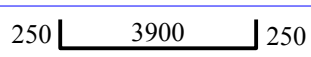
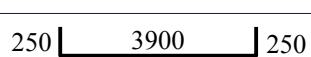
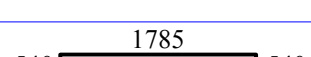
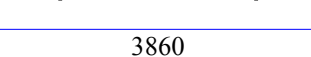
构件名称	级直 别径	钢筋简图	下料 (mm)	根件 数*数	总 根数	备 注
	Φ28	280  280	3545	1*2	2	@200
	Φ28	280  280	3195	1*2	2	@200
	Φ28	280  280	2845	1*2	2	@200
	Φ28	280  280	2500	1*2	2	@200
	Φ28	280  280	2150	1*2	2	@200
	Φ28	280  280	1800	1*2	2	@200
	Φ28	280  280	1450	1*2	2	@200
CT3b 12#面 筋	Φ28	280  280	4050	5*2	10	Y向, @200
CT3b 13#面 筋	Φ28	280  280	2670	1*2	2	Y向, @200
	Φ28	280  280	1405	1*2	2	@200
	Φ28	280  280	3370	1*2	2	@200
	Φ28	280  280	1625	1*2	2	@200
	Φ28	280  280	3020	1*2	2	@200
	Φ28	280  280	1975	1*2	2	@200
	Φ28	280  280	3720	1*2	2	@200
	Φ28	280  280	2325	1*2	2	@200
	CT4a	Φ25	250  250	4300	31*2	62
Φ25		250  250	4300	31*2	62	Y向,@130
Φ18		540  540	2790	80*2	160	封边竖向@200
Φ12		250  250	4310	28*2	56	封边水平@200

审核:

翻样: 秦黄海 13574434596 第6页,共35页 2017/2/19 星期日 9:57





钢筋配料表

料单编号:16102816

项目名称: 荆州一医地下室

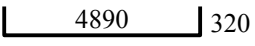
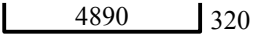
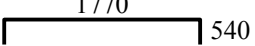
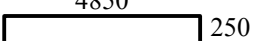
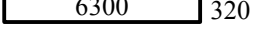
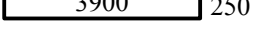
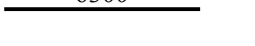
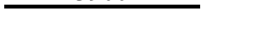
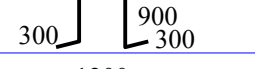
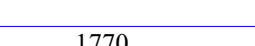
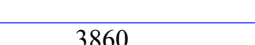
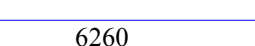
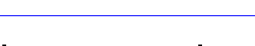
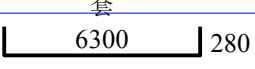
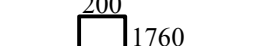
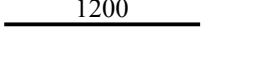
部位: 基础_塔楼A_承台

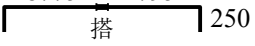
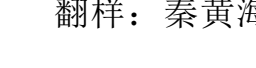
构件名称	级直别径	钢筋简图	下料(mm)	根件数*数	总根数	备注
CT5a	Φ32	320  320	5400	32	32	X向,@160
	Φ32	320  320	5400	32	32	Y向,@160
	Φ18	540  540	2780	98	98	封边竖向@200
	Φ12	250  250	5300	28	28	封边水平@200
CT6a	Φ32	320  320	6810	31*3	93	X向,@130
	Φ25	250  250	4300	50*3	150	Y向,@130
	Φ18	 6300	6300	21*3	63	X向,@200.中部网片
	Φ18	 3900	3900	33*3	99	Y向,@200.中部网片
	Φ25		2400	24*3	72	马镫每平方1个
	Φ25	 1200	1200	48*3	144	斜向支撑每个马镫2个
	Φ18	540  540	2780	102*3	306	封边竖向@200
	Φ12	250  250	4310	14*3	42	Y封边水平@200
	Φ12	250  250	6710	14*3	42	X封边水平@200
	FB1 底筋	Φ25	250  250 套	9000 2500	49*2	98
Φ28		280  280	6750	57*2	114	Y向,@200
Φ25			4120	69*2	138	马镫每平方1个
Φ25		 1200	1200	138*2	276	斜向支撑每个马镫2个
Φ18		540  540	2760	174*2	348	封边竖向@200
Φ12		250  250	6710	14*2	28	Y封边水平@200
Φ12		250  250 搭	9000 3020	14*2	28	长:11060, 搭接510mm,X封边水 平@200

审核:

翻样: 秦黄海 13574434596 第7页,共35页 2017/2/19 星期日 9:57



钢筋配料表

料单编号:16102816

项目名称: 荆州一医地下室

部位: 基础_塔楼A_承台

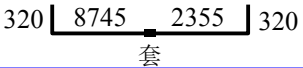
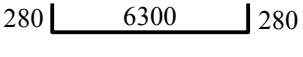
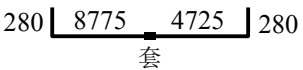
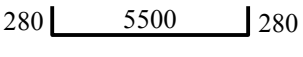
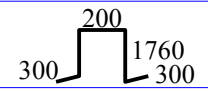
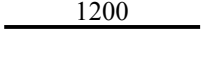
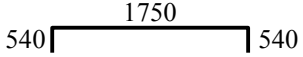
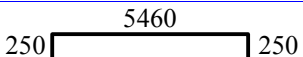
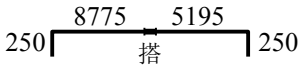
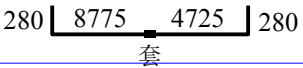
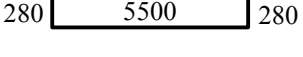
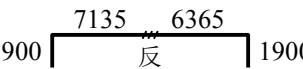
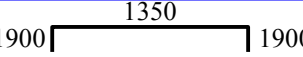
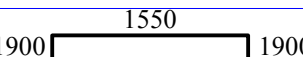
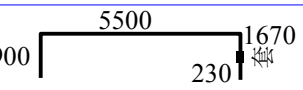
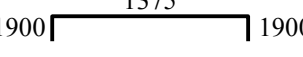
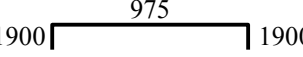
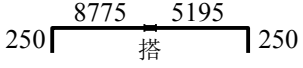
构件名称	级直别径	钢筋简图	下料 (mm)	根件 数*数	总 根数	备注
FB1 面筋	Φ32	320  320 套	9000 2610	49*2	98	长:11100, X向,@130
	Φ28	280  280	6750	57*2	114	Y向,@200
以下为FB5料单, 绑扎详图另出						
FB5 底筋	Φ28	280  280 套	9000 4950	29*2	58	长:13500, X向,@200
	Φ28	280  280	5950	69*2	138	Y向,@200
	Φ25		4120	74*2	148	马镫每平方1个
	Φ25		1200	148*2	296	斜向支撑每个马镫2 个
	Φ18	540  540	2760	174*2	348	封边竖向@200
	Φ12	250  250	5910	14*2	28	Y封边水平@200
	Φ12	250  250 搭	9000 5420	14*2	28	长:13460, 搭接510mm,X封边水 平@200
FB5 面筋	Φ28	280  280 套	9000 4950	29*2	58	长:13500, X向,@200
	Φ28	280  280	5950	69*2	138	Y向,@200
FB5 1#顶部 面筋	Φ18	1900  1900 反	9000 8230	14	14	@200 总长13500
FB5 2#顶部 面筋	Φ18	1900  1900	5080	15	15	@200
FB5 3#顶部 面筋	Φ18	1900  1900	5280	15	15	@200
FB5 4#顶部 面筋	Φ18	1900  1900 230	9000 230	17	17	@200 总长5500
FB5 5#顶部 面筋	Φ18	1900  1900	5105	52	52	@200
FB5 6#顶部 面筋	Φ18	1900  1900	4705	52	52	@200
	Φ12	250  250 搭	9000 5420	8	8	长:13460, 搭接510mm,1#封边水平 @200

审核:

翻样: 秦黄海 13574434596 第8页,共35页 2017/2/19 星期日 9:57



钢筋配料表

料单编号:16102816

项目名称: 荆州一医地下室

部位: 基础_塔楼A_承台

构件名称	级直别径	钢筋简图	下料 (mm)	根件 数*数	总 根数	备 注
	Φ12	250 250	5910	8	8	2#封边水平@200
	Φ12	4000	4000	12	12	3#封边水平@200用于 电梯井壁
	Φ12	9000 2910 搭	9000 2910	12	12	长:11400, 搭接510mm,4#封边水平 @200用于电梯井壁
以下为FB11料单, 绑扎详图另出						
FB11 1#底筋	Φ28	280 280	9000 1260	65	65	总长9814
FB11 2#底筋	Φ28	280 280	9000 820	1	1	总长9370
	Φ28	280 280	6000 3230	1	1	总长8781
	Φ28	280 280	8640	1	1	
	Φ28	280 280	8050	1	1	
	Φ28	280 280	7460	1	1	
	Φ28	280 280	6875	1	1	
	Φ28	280 280	6285	1	1	
	Φ28	280 280	5695	1	1	
	Φ28	280 280	5105	1	1	
	FB11 3#底筋	Φ28	280 280	2980 8945	1	1
Φ28		280 280	2885 8945	1	1	总长11380
Φ28		280 280	2785 8945	1	1	总长11281
Φ28		280 280	2685 8945	1	1	总长11183
Φ28		280 280	2590 8945	1	1	总长11085
Φ28		280 280	2490 8945	1	1	总长10987

审核:

翻样: 秦黄海 13574434596 第9页,共35页 2017/2/19 星期日 9:57



钢筋配料表

料单编号:16102816

项目名称: 荆州一医地下室

部位: 基础_塔楼A_承台

构件名称	级直别径	钢筋简图	下料 (mm)	根件 数*数	总 根数	备 注
	Φ28	280 280	2395 8945	1	1	总长10889
	Φ28	280 280	2295 8945	1	1	总长10791
FB11 4#底 筋	Φ28	280 280	3765 8945	1	1	总长12263
	Φ28	280 280	3670 8945	1	1	总长12165
	Φ28	280 280	3570 8945	1	1	总长12067
	Φ28	280 280	3475 8945	1	1	总长11969
	Φ28	280 280	3375 8945	1	1	总长11870
	Φ28	280 280	3275 8945	1	1	总长11772
	Φ28	280 280	3180 8945	1	1	总长11674
	Φ28	280 280	3080 8945	1	1	总长11576
FB11 5#底 筋	Φ28	280 280	3805 8945	27	27	总长12300
FB11 6#底 筋	Φ28	280 280	3055 8945	1	1	总长11549
	Φ28	280 280	3150 8945	1	1	总长11647
	Φ28	280 280	3250 8945	1	1	总长11746
	Φ28	280 280	3350 8945	1	1	总长11844
	Φ28	280 280	3445 8945	1	1	总长11942
	Φ28	280 280	3545 8945	1	1	总长12040
	Φ28	280 280	3640 8945	1	1	总长12138
	Φ28	280 280	3740 8945	1	1	总长12236
FB11 7#底 筋	Φ28	280 280	2270 8945	1	1	总长10764

审核:

翻样: 秦黄海 13574434596 第 10 页,共35页 2017/2/19 星期日 9:57



钢筋配料表

料单编号:16102816

项目名称: 荆州一医地下室

部位: 基础_塔楼A_承台

构件名称	级直别径	钢筋简图	下料 (mm)	根件 数*数	总 根数	备 注
	Φ28		2365 8945	1	1	总长10862
	Φ28		2465 8945	1	1	总长10960
	Φ28		2565 8945	1	1	总长11059
	Φ28		2660 8945	1	1	总长11157
	Φ28		2760 8945	1	1	总长11255
	Φ28		2855 8945	1	1	总长11353
	Φ28		2955 8945	1	1	总长11451
	Φ25		4120	118	118	马镫每平方1个
	Φ25		1200	236	236	斜向支撑每个马镫2个
	Φ18		2760	174*2	348	封边竖向。@200
	Φ12		4995	7	7	1#封边水平@200
	Φ12		3670	14	14	2#封边水平@200
	Φ12		9000 2690	14	14	长:10710, 搭接510mm,3#封边水平 @200
	Φ12		9000 1700	14	14	长:9740, 搭接510mm,4#封边水 平@200
FB11 1#面筋	Φ28		9000 1260	65	65	总长9814
FB11 2#面筋	Φ28		9000 820	1	1	总长9370
	Φ28		6000 3230	1	1	总长8781
	Φ28		8640	1	1	
	Φ28		8050	1	1	
	Φ28		7460	1	1	

审核:

翻样: 秦黄海 13574434596 第 11 页,共35页 2017/2/19 星期日 9:57



钢筋配料表

料单编号:16102816

项目名称: 荆州一医地下室

部位: 基础_塔楼A_承台

构件名称	级直别径	钢筋简图	下料 (mm)	根 件 数*数	总 根 数	备 注
	Φ28	280 280	6875	1	1	
	Φ28	280 280	6285	1	1	
	Φ28	280 280	5695	1	1	
	Φ28	280 280	5105	1	1	
FB11 3#面 筋	Φ28	280 280	2980 8945	1	1	总长11478
	Φ28	280 280	2885 8945	1	1	总长11380
	Φ28	280 280	2785 8945	1	1	总长11281
	Φ28	280 280	2685 8945	1	1	总长11183
	Φ28	280 280	2590 8945	1	1	总长11085
	Φ28	280 280	2490 8945	1	1	总长10987
	Φ28	280 280	2395 8945	1	1	总长10889
	Φ28	280 280	2295 8945	1	1	总长10791
FB11 4#面 筋	Φ28	280 280	3765 8945	1	1	总长12263
	Φ28	280 280	3670 8945	1	1	总长12165
	Φ28	280 280	3570 8945	1	1	总长12067
	Φ28	280 280	3475 8945	1	1	总长11969
	Φ28	280 280	3375 8945	1	1	总长11870
	Φ28	280 280	3275 8945	1	1	总长11772
	Φ28	280 280	3180 8945	1	1	总长11674
	Φ28	280 280	3080 8945	1	1	总长11576

审核:

翻样: 秦黄海 13574434596 第 12 页,共35页 2017/2/19 星期日 9:57



钢筋配料表

料单编号:16102816

项目名称: 荆州一医地下室

部位: 基础_塔楼A_承台

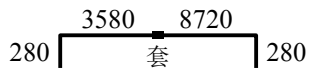
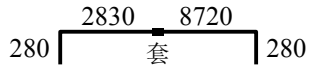
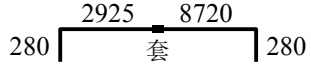
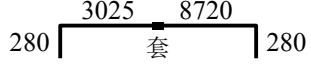
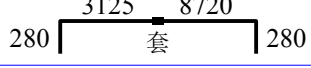
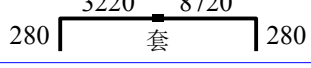
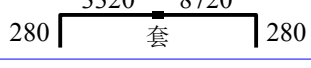
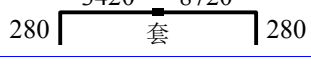
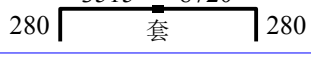
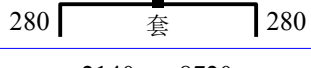
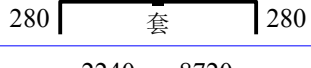
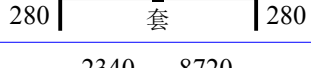
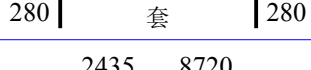
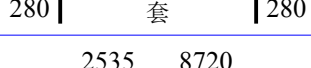
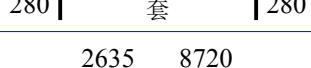
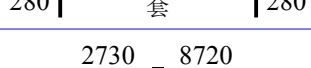
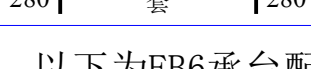
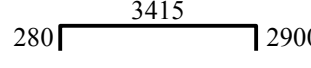
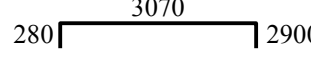
构件名称	级直别径	钢筋简图	下料 (mm)	根件 数*数	总 根数	备 注
FB11 5#面筋	Φ28		3805 8945	27	27	总长12300
FB11 6#面筋	Φ28		3055 8945	1	1	总长11549
	Φ28		3150 8945	1	1	总长11647
	Φ28		3250 8945	1	1	总长11746
	Φ28		3350 8945	1	1	总长11844
	Φ28		3445 8945	1	1	总长11942
	Φ28		3545 8945	1	1	总长12040
	Φ28		3640 8945	1	1	总长12138
	Φ28		3740 8945	1	1	总长12236
FB11 7#面筋	Φ28		2270 8945	1	1	总长10764
	Φ28		2365 8945	1	1	总长10862
	Φ28		2465 8945	1	1	总长10960
	Φ28		2565 8945	1	1	总长11059
	Φ28		2660 8945	1	1	总长11157
	Φ28		2760 8945	1	1	总长11255
	Φ28		2855 8945	1	1	总长11353
	Φ28		2955 8945	1	1	总长11451
以下为FB6承台配料单, 绑扎详图另出						
FB6 1#筋	Φ28		6485	1	1	
	Φ28		6135	1	1	

审核:

翻样: 秦黄海 13574434596 第 13 页,共35页 2017/2/19 星期日 9:57



钢筋配料表

料单编号:16102816

项目名称: 荆州一医地下室

部位: 基础_塔楼A_承台

构件名称	级直别径	钢筋简图	下料 (mm)	根件 数*数	总 根数	备 注
	Φ28	280 2900	5790	1	1	
	Φ28	280 2900	5445	1	1	
	Φ28	280 2900	5095	1	1	
	Φ28	280 2900	4750	1	1	
	Φ28	280 2900	4405	1	1	
	Φ28	280 2900	4060	1	1	
FB6 2#筋	Φ28	280 2900	8560	1	1	
	Φ28	280 2900	8215	1	1	
	Φ28	280 2900	7870	1	1	
	Φ28	280 2900	7520	1	1	
	Φ28	280 2900	7175	1	1	
	Φ28	280 2900	6830	1	1	
FB6 3#筋	Φ28	280 2900	1295 9000	1	1	总长7225
	Φ28	280 2900	6000 3945	1	1	总长6879
	Φ28	280 2900	600 9000	1	1	总长6532
	Φ28	280 2900	6000 3255	1	1	总长6186
	Φ28	280 2900	8910	1	1	
FB6 4#筋	Φ28	2900 2900	9000 4225	37	37	总长7536
FB6 5#筋	Φ28	2900 280	8905	1	1	总长5835
	Φ28	2900 280	6000 3250	1	1	总长6182

审核:

翻样: 秦黄海 13574434596 第 14 页,共35页 2017/2/19 星期日 9:57



钢筋配料表

料单编号:16102816

项目名称: 荆州一医地下室

部位: 基础_塔楼A_承台

构件名称	级直别径	钢筋简图	下料 (mm)	根件 数*数	总 根数	备 注
	Φ28		595 9000	1	1	总长6528
	Φ28		6000 3945	1	1	总长6875
	Φ28		8210	1	1	
	Φ28		8555	1	1	
FB6 6#筋	Φ28		7520	1	1	
	Φ28		6130	1	1	
	Φ28		7170	1	1	
	Φ28		6480	1	1	
	Φ28		7865	1	1	
	Φ28		6825	1	1	
FB6 7#筋	Φ28		1605 9000	1	1	总长10159
	Φ28		1490 9000	1	1	总长10044
	Φ28		1375 9000	1	1	总长9928
	Φ28		1260 9000	1	1	总长9813
	Φ28		1145 9000	1	1	总长9697
FB6 8#筋	Φ28		2185 9000	1	1	总长10736
	Φ28		2070 9000	1	1	总长10621
	Φ28		1955 9000	1	1	总长10505
	Φ28		1840 9000	1	1	总长10390
	Φ28		1725 9000	1	1	总长10275

审核:

翻样: 秦黄海 13574434596 第 15 页,共35页 2017/2/19 星期日 9:57







钢筋配料表

料单编号:16102816

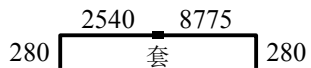
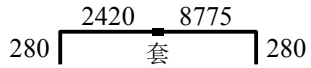
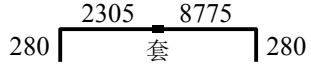
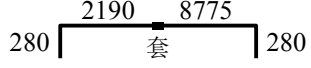
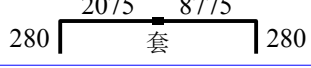
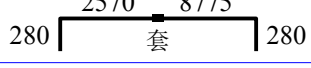
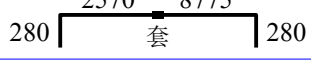
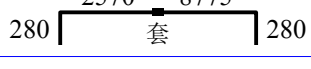
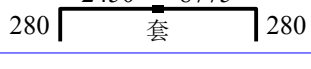
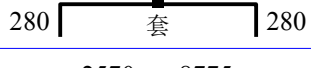
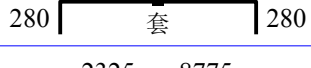
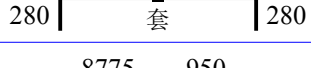
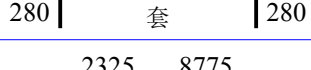
项目名称: 荆州一医地下室

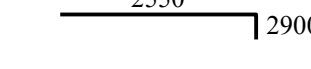
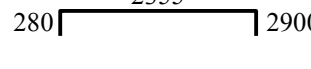
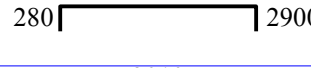
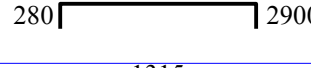
部位: 基础_塔楼A_承台

构件名称	级直别径	钢筋简图	下料 (mm)	根件 数*数	总 根数	备 注
FB6 9#筋	Φ28		2760 9000	1	1	总长11314
	Φ28		2645 9000	1	1	总长11198
	Φ28		2530 9000	1	1	总长11083
	Φ28		2415 9000	1	1	总长10967
	Φ28		2300 9000	1	1	总长10852
FB6 10#筋	Φ28		2795 9000	5	5	总长11347
FB6 11#筋	Φ28		2795 9000	5	5	总长11347
FB6 12#筋	Φ28		2795 9000	5	5	总长11347
FB6 13#筋	Φ28		2670 9000	1	1	总长11224
	Φ28		2790 9000	1	1	总长11340
	Φ28		2795 9000	3	3	总长11347
FB6 14#筋	Φ28		2550 9000	3	3	总长11100
FB6 31#水平筋	Φ28		9000 1175	9	9	@200 总长9726
FB6 32#水平筋	Φ28		2550 9000	9	9	@200 总长11100
以上为FB6电梯井底部钢筋						
FB6 15#附加筋	Φ28		5395	51	51	@200
FB6 16#附加筋	Φ28		5425	1	1	
	Φ28		4040	1	1	
	Φ28		5080	1	1	
	Φ28		4385	1	1	

审核:

翻样: 秦黄海 13574434596 第 16 页,共35页 2017/2/19 星期日 9:57



钢筋配料表

料单编号:16102816

项目名称: 荆州一医地下室

部位: 基础_塔楼A_承台

构件名称	级直别径	钢筋简图	下料 (mm)	根件 数*数	总 根数	备 注
	Φ28	280 2900	4730	1	1	
FB6 17#附加筋	Φ28	4250	4250	56	56	@200
FB6 18#附加筋	Φ28	280 2900	6290	26	26	@200
FB6 19#筋	Φ28	280 2900	3450	43	43	
FB6 20#筋	Φ28	280 2900	2780	1	1	
	Φ28	280 2900	1395	1	1	
	Φ28	280 2900	2435	1	1	
	Φ28	280 2900	1740	1	1	
	Φ28	280 2900	3125	1	1	
	Φ28	280 2900	2085	1	1	
FB6 21#筋	Φ28	280	1130 9000	27	27	总长9904
	Φ28	280	9000 1130	27	27	总长9904
FB6 21a#筋	Φ28	280 280	9000 835	1	1	总长9385
	Φ28	280 280	1180 9000	1	1	总长9731
FB6 22#筋	Φ28	280 280	1415 8000	1	1	总长8968
	Φ28	280 280	1300 8000	1	1	总长8852
	Φ28	280 280	1185 8000	1	1	总长8737
	Φ28	280 280	1070 8000	1	1	总长8622
	Φ28	280 280	8955	1	1	
	Φ28	280 280	8840	1	1	

审核:

翻样: 秦黄海 13574434596 第 17 页,共35页 2017/2/19 星期日 9:57



钢筋配料表

料单编号:16102816

项目名称: 荆州一医地下室

部位: 基础_塔楼A_承台

构件名称	级直 别径	钢筋简图	下料 (mm)	根件 数*数	总 根数	备 注
FB6 23#筋	Φ28		1110 9000	1	1	总长9661
	Φ28		995 9000	1	1	总长9545
	Φ28		880 9000	1	1	总长9430
	Φ28		760 9000	1	1	总长9314
	Φ28		645 9000	1	1	总长9199
	Φ28		530 9000	1	1	总长9083
FB6 24#筋	Φ28		2550 9000	45	45	总长11100
	Φ28		1180 9000	1	1	总长9731
以下为FB6电梯井坑面层						
FB6 25#筋	Φ28		4010	1	1	
	Φ28		3665	1	1	
	Φ28		3320	1	1	
	Φ28		2970	1	1	
	Φ28		2625	1	1	
	Φ28		2280	1	1	
	Φ28		1930	1	1	
	Φ28		1585	1	1	
FB6 26#筋	Φ28		4200	45	45	
FB6 27#筋	Φ28		3980	1	1	
	Φ28		1210	1	1	

审核:

翻样: 秦黄海 13574434596 第 18 页,共35页 2017/2/19 星期日 9:57



钢筋配料表

料单编号:16102816

项目名称: 荆州一医地下室

部位: 基础_塔楼A_承台

构件名称	级直 别径	钢筋简图	下料 (mm)	根件 数*数	总 根数	备 注
	Φ28		3290	1	1	
	Φ28		1555	1	1	
	Φ28		2945	1	1	
	Φ28		1905	1	1	
	Φ28		3635	1	1	
	Φ28		2250	1	1	
	Φ28		2595	1	1	
FB6 28#筋	Φ28		2735 9000	1	1	总长11285
	Φ28		2620 9000	1	1	总长11170
	Φ28		2505 9000	1	1	总长11055
FB6 29#筋	Φ28		2795 9000	5	5	总长11347
FB6 30#筋	Φ28		2795 9000	4	4	总长11347
FB6 33#斜 向筋	Φ28		4135	51	51	@200
	Φ28		4135	49	49	@200
FB6 34#斜 向筋	Φ28		3330	1	1	
	Φ28		3675	1	1	
	Φ28		4025	1	1	
FB6 35#斜 坡水平筋	Φ28		9428 ~10828	11	11	△140mm,
FB6 36#斜 坡水平筋	Φ28		11598 ~11798	11	11	△20mm,
以下为FB6面层						

审核:

翻样: 秦黄海 13574434596 第 19 页,共35页 2017/2/19 星期日 9:57



钢筋配料表

料单编号:16102816

项目名称: 荆州一医地下室

部位: 基础_塔楼A_承台

构件名称	级直 别径	钢筋简图	下料 (mm)	根 件 数*数	总 根 数	备 注
FB6 37#筋	Φ28		1300 8000	1	1	总长8853
	Φ28		1185 8000	1	1	总长8737
	Φ28		1070 8000	1	1	总长8622
	Φ28		8955	1	1	
	Φ28		8840	1	1	
FB6 38#筋	Φ28		880 9000	1	1	总长9430
	Φ28		760 9000	1	1	总长9314
	Φ28		645 9000	1	1	总长9199
	Φ28		530 9000	1	1	总长9084
	Φ28		415 9000	1	1	总长8968
FB6 39#筋	Φ28		1455 9000	1	1	总长10007
	Φ28		1340 9000	1	1	总长9892
	Φ28		1225 9000	1	1	总长9776
	Φ28		1110 9000	1	1	总长9661
	Φ28		995 9000	1	1	总长9545
FB6 40#筋	Φ28		2035 9000	1	1	总长10585
	Φ28		1915 9000	1	1	总长10469
	Φ28		1800 9000	1	1	总长10354
	Φ28		1685 9000	1	1	总长10238
	Φ28		1570 9000	1	1	总长10123

审核:

翻样: 秦黄海 13574434596 第 20 页,共35页 2017/2/19 星期日 9:57



钢筋配料表

料单编号:16102816

项目名称: 荆州一医地下室

部位: 基础_塔楼A_承台

构件名称	级直别径	钢筋简图	下料 (mm)	根件 数*数	总 根数	备 注
FB6 41#筋	Φ28		2380 9000	1	1	总长10931
	Φ28		2265 9000	1	1	总长10816
	Φ28		2150 9000	1	1	总长10700
FB6 42#筋	Φ18		6950	3	3	
FB6 43#筋	Φ18		6900	1	1	
	Φ18		5980	1	1	
	Φ18		6670	1	1	
	Φ18		6095	1	1	
	Φ18		6555	1	1	
	Φ18		6210	1	1	
	Φ18		6785	1	1	
	Φ18		6325	1	1	
	Φ18		6440	1	1	
	FB6 44#筋	Φ18		7965	1	1
Φ18			7850	1	1	
Φ18			7735	1	1	
Φ18			7620	1	1	
Φ18			7505	1	1	
Φ18			7385	1	1	
Φ18			7270	1	1	

审核:

翻样: 秦黄海 13574434596 第 21 页,共35页 2017/2/19 星期日 9:57



钢筋配料表

料单编号:16102816

项目名称: 荆州一医地下室

部位: 基础_塔楼A_承台

构件名称	级直别径	钢筋简图	下料 (mm)	根件 数*数	总 根数	备 注
	Φ18	1900 1900	7155	1	1	
	Φ18	1900 1900	7040	1	1	
	Φ18	1900 1900	6925	1	1	
	Φ18	1900 1900	6810	1	1	
	Φ18	1900 1900	6695	1	1	
FB6 45#筋	Φ28	280 280	2815 9000	6	6	总长11367
FB6 46#筋	Φ28	280 280	2615 9000	1	1	总长11165
	Φ28	280 280	2730 9000	1	1	总长11281
	Φ28	280 280	2815 9000	4	4	总长11367
FB6 47#筋	Φ28	280 280	2570 9000	44	44	总长11120
FB6 48#筋	Φ28	280 280	6840	1	1	
	Φ28	280 280	5630	1	1	
	Φ28	280 280	7530	1	1	
	Φ28	280 280	5800	1	1	
	Φ28	280 280	7185	1	1	
	Φ28	280 280	6145	1	1	
	Φ28	280 280	6490	1	1	
FB6 49#筋	Φ28	280 280	8000 1265	1	1	总长8815
	Φ28	280 280	8000 1610	1	1	总长9162
	Φ28	280 280	7880	1	1	

审核:

翻样: 秦黄海 13574434596 第 22 页,共35页 2017/2/19 星期日 9:57



钢筋配料表

料单编号:16102816

项目名称: 荆州一医地下室

部位: 基础_塔楼A_承台

构件名称	级直别径	钢筋简图	下料 (mm)	根件 数*数	总 根数	备 注
	Φ28	280 $\overbrace{\hspace{1.5cm}}^{7775}$ 280	8225	1	1	
	Φ28	280 $\overbrace{\hspace{1.5cm}}^{8470}$ 280	8915	1	1	
	Φ28	280 $\overbrace{\hspace{1.5cm}}^{8125}$ 280	8570	1	1	
FB6 50#筋	Φ28	280 $\overbrace{\hspace{1.5cm}}^{1575 \quad 9000 \quad 7570}$ 280 套 套	1800 9000 7795	6	6	总长18148
FB6 51#筋	Φ28	280 $\overbrace{\hspace{1.5cm}}^{4535}$ 2200	6900	24	24	
FB6 52#筋	Φ28	2200 $\overbrace{\hspace{1.5cm}}^{2460 \quad 8775}$ 280 套	4600 9000	12	12	总长11234
	Φ28	2200 $\overbrace{\hspace{1.5cm}}^{6855 \quad 4380}$ 280 套	9000 4600	12	12	总长11234
FB6 53#筋	Φ28	280 $\overbrace{\hspace{1.5cm}}^{1575 \quad 9000 \quad 7400}$ 280 套 套	1800 9000 7625	1	1	总长17975
	Φ28	280 $\overbrace{\hspace{1.5cm}}^{1575 \quad 9000 \quad 7055}$ 280 套 套	1800 9000 7275	1	1	总长17629
	Φ28	280 $\overbrace{\hspace{1.5cm}}^{1575 \quad 9000 \quad 6705}$ 280 套 套	1800 9000 6930	1	1	总长17282
	Φ28	280 $\overbrace{\hspace{1.5cm}}^{1575 \quad 9000 \quad 6360}$ 280 套 套	1800 9000 6585	1	1	总长16936
	Φ28	280 $\overbrace{\hspace{1.5cm}}^{1575 \quad 9000 \quad 6015}$ 280 套 套	1800 9000 6235	1	1	总长16589
FB6 54#筋	Φ28	280 $\overbrace{\hspace{1.5cm}}^{8775 \quad 7465}$ 280 套	9000 7690	1	1	总长16243
	Φ28	280 $\overbrace{\hspace{1.5cm}}^{8775 \quad 7120}$ 280 套	9000 7345	1	1	总长15897
	Φ28	280 $\overbrace{\hspace{1.5cm}}^{8775 \quad 6775}$ 280 套	9000 7000	1	1	总长15550
	Φ28	280 $\overbrace{\hspace{1.5cm}}^{8775 \quad 6430}$ 280 套	9000 6650	1	1	总长15204
	Φ28	280 $\overbrace{\hspace{1.5cm}}^{8775 \quad 6080}$ 280 套	9000 6305	1	1	总长14857
FB6 55#筋	Φ28	280 $\overbrace{\hspace{1.5cm}}^{8775 \quad 5735}$ 280 套	9000 5960	1	1	总长14511

审核:

翻样: 秦黄海 13574434596 第 23 页,共35页 2017/2/19 星期日 9:57



钢筋配料表

料单编号:16102816

项目名称: 荆州一医地下室

部位: 基础_塔楼A_承台

构件名称	级直别径	钢筋简图	下料 (mm)	根件 数*数	总 根数	备 注
	Φ28		9000 5615	1	1	总长14165
	Φ28		9000 5265	1	1	总长13818
	Φ28		9000 4920	1	1	总长13472
	Φ28		9000 4575	1	1	总长13125
FB6 56#筋	Φ28		9000 4225	1	1	总长12779
	Φ28		9000 3880	1	1	总长12432
	Φ28		9000 3535	1	1	总长12086
	Φ28		9000 3190	1	1	总长11740
	Φ28		9000 2840	1	1	总长11393
FB6 57#筋	Φ28		9000 2495	1	1	总长11047
	Φ28		9000 2150	1	1	总长10700
	Φ28		9000 1800	1	1	总长10354
	Φ28		9000 1455	1	1	总长10008
	Φ28		9000 1110	1	1	总长9661
	Φ28		9000 765	1	1	总长9315
	Φ25		4120	199	199	马镫每平方1个
	Φ25		1800	398	398	斜向支撑每个马镫2个
以下为FB6封边及封边水平分布筋						
	Φ18		4050	83	83	封边竖向。@200用于深处
	Φ18		2750	206	206	封边竖向。@200

审核:

翻样: 秦黄海 13574434596 第 24 页,共35页 2017/2/19 星期日 9:57



钢筋配料表

料单编号:16102816

项目名称: 荆州一医地下室

部位: 基础_塔楼A_承台

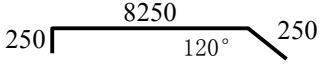
构件名称	级直别径	钢筋简图	下料 (mm)	根件 数*数	总 根数	备 注
58#水平分布筋	Φ12		3150	6*2	12	@200
59#水平分布筋	Φ28		4000	6*2	12	@200
60#水平分布筋	Φ12		3270	6	6	@200
61#水平分布筋	Φ12		5445	14	14	@200
62#水平分布筋	Φ12		8090	6	6	@200
63#水平分布筋	Φ12		5440	8	8	@200
64#水平分布筋	Φ12		8720	8	8	@200
65#水平分布筋	Φ12		9000 2120	4	4	长:10120, 搭接510mm,@200
65#水平分布筋	Φ12		2120 9000	4	4	长:10120, 搭接510mm,@200
66#水平分布筋	Φ12		9000 1100	4	4	长:9120, 搭接510mm,@200
66#水平分布筋	Φ12		1100 9000	4	4	长:9120, 搭接510mm,@200
67#水平分布筋	Φ12		2940 9000	8	8	长:10980, 搭接510mm,@200
68#水平分布筋	Φ12		1035 9000	4	4	长:9300, 搭接510mm,@200
68#水平分布筋	Φ12		9000 1035	4	4	长:9300, 搭接510mm,@200
以下为FB3料单 绑扎详图另出						
FB3 1#筋	Φ28		5640	1	1	
	Φ28		5465	1	1	
	Φ28		5285	1	1	
	Φ28		5105	1	1	
	Φ28		4930	1	1	

审核:

翻样: 秦黄海 13574434596 第 25 页,共35页 2017/2/19 星期日 9:57



钢筋配料表

料单编号:16102816

项目名称: 荆州一医地下室

部位: 基础_塔楼A_承台

构件名称	级直别径	钢筋简图	下料 (mm)	根件 数*数	总 根数	备 注
	Φ28	280 280	4750	1	1	
FB3 2#筋	Φ28	280 280	6530	1	1	
	Φ28	280 280	6350	1	1	
	Φ28	280 280	6175	1	1	
	Φ28	280 280	5995	1	1	
	Φ28	280 280	5820	1	1	
FB3 2a#筋	Φ28	1630 280 1270 套	1270 8000	16	16	
	Φ28	2630 280 270 套	270 9000	15	15	
FB3 3#筋	Φ28	2900 280 -1100 套	1745 7220	1	1	总长5894
	Φ28	2900 280 -1100 套	1745 7395	1	1	总长6071
	Φ28	2900 280	8430	1	1	
	Φ28	2900 280	8605	1	1	
	Φ28	2900 280	8785	1	1	
FB3 4#筋	Φ28	2900 280	8075	1	1	
	Φ28	2900 280	7715	1	1	
	Φ28	2900 280	8250	1	1	
	Φ28	2900 280	7895	1	1	
FB3 5#筋	Φ28	280 280	4890	1	1	
	Φ28	280 280	4535	1	1	

审核:

翻样: 秦黄海 13574434596 第 26 页,共35页 2017/2/19 星期日 9:57



钢筋配料表

料单编号:16102816

项目名称: 荆州一医地下室

部位: 基础_塔楼A_承台

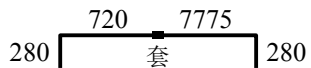
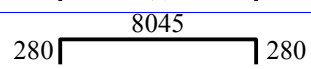
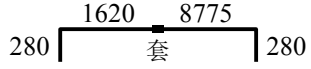
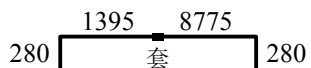
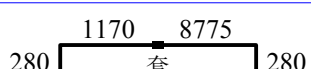
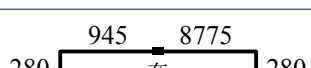
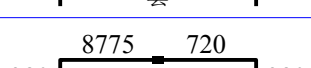
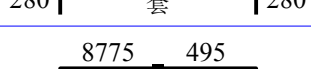
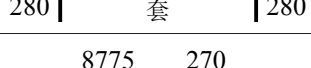
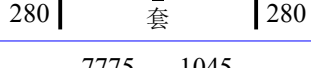
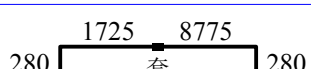
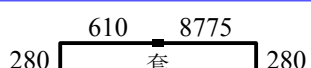
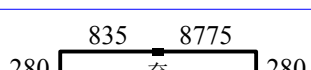
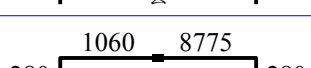
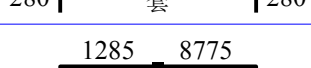
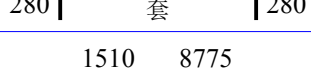
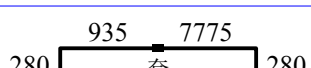
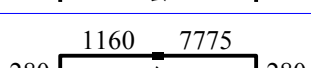
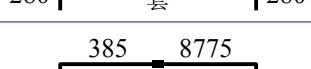
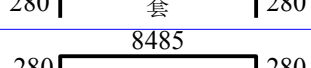
构件名称	级直 别径	钢筋简图	下料 (mm)	根 件 数*数	总 根 数	备 注
FB3 6#筋	Φ28		940 8000	1	1	总长8494
	Φ28		8490	1	1	
FB3 7#筋	Φ28		1845 9000	1	1	总长10397
	Φ28		1620 9000	1	1	总长10172
	Φ28		1395 9000	1	1	总长9947
	Φ28		1170 9000	1	1	总长9722
	Φ28		9000 945	1	1	总长9497
	Φ28		9000 720	1	1	总长9272
	Φ28		9000 495	1	1	总长9047
	Φ28		8000 1270	1	1	总长8822
FB3 8#筋	Φ28		1950 9000	12	12	总长10500
FB3 9#筋	Φ28		835 9000	1	1	总长9387
	Φ28		1060 9000	1	1	总长9612
	Φ28		1285 9000	1	1	总长9837
	Φ28		1510 9000	1	1	总长10062
	Φ28		1735 9000	1	1	总长10287
FB3 10#筋	Φ28		1160 8000	1	1	总长8712
	Φ28		1385 8000	1	1	总长8937
	Φ28		610 9000	1	1	总长9162
	Φ28		8935	1	1	

审核:

翻样: 秦黄海 13574434596 第 27 页,共35页 2017/2/19 星期日 9:57







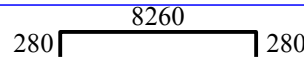
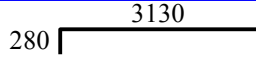
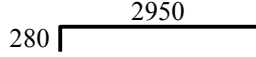
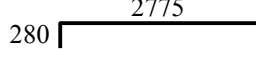
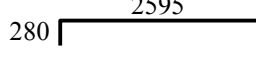
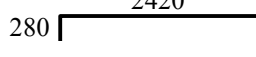
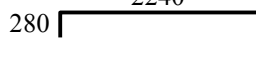
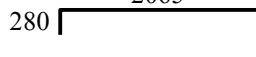

钢筋配料表

料单编号:16102816

项目名称: 荆州一医地下室

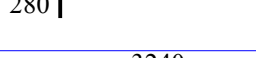
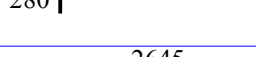
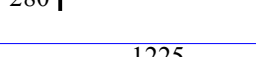
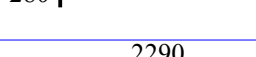
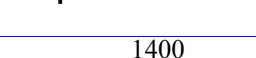
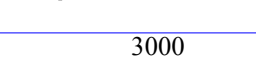
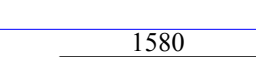
部位: 基础_塔楼A_承台

构件名称	级直 别径	钢筋简图	下料 (mm)	根件 数*数	总 根数	备 注
	Φ28	280  280	8710	1	1	
FB3 11#筋	Φ28	280  280	3355	1	1	@200
	Φ28	280  280	3175	1	1	@200
	Φ28	280  280	3000	1	1	@200
	Φ28	280  280	2820	1	1	@200
	Φ28	280  280	2645	1	1	@200
	Φ28	280  280	2465	1	1	@200
	Φ28	280  280	2285	1	1	@200
	Φ28	280  280	2110	1	1	@200
	Φ28	280  280	1930	1	1	@200
	Φ28	280  280	1755	1	1	@200
	Φ28	280  280	1575	1	1	@200
	Φ28	280  280	1400	1	1	@200
	FB3 12#筋	Φ28	280  280	3465	21	21
FB3 13#筋	Φ28	280  280	2870	1	1	@200
	Φ28	280  280	1450	1	1	@200
	Φ28	280  280	2515	1	1	@200
	Φ28	280  280	1625	1	1	@200
	Φ28	280  280	3225	1	1	@200
	Φ28	280  280	1805	1	1	@200

审核:

翻样: 秦黄海 13574434596 第 28 页,共35页 2017/2/19 星期日 9:57



钢筋配料表

料单编号:16102816

项目名称: 荆州一医地下室

部位: 基础_塔楼A_承台

构件名称	级直别径	钢筋简图	下料(mm)	根件数*数	总根数	备注
	Φ28	280 2470	2695	1	1	@200
	Φ28	280 1760	1980	1	1	@200
	Φ28	280 2825	3050	1	1	@200
	Φ28	280 1935	2160	1	1	@200
	Φ28	280 3180	3405	1	1	@200
	Φ28	280 2115	2335	1	1	@200
FB3 14#筋	Φ28	280 6920 280	7370	1	1	@200
	Φ28	280 6470 280	6920	1	1	@200
	Φ28	280 6020 280	6470	1	1	@200
	Φ28	280 5570 280	6020	1	1	@200
	Φ28	280 5120 280	5570	1	1	@200
	Φ28	280 4670 280	5120	1	1	@200
	Φ28	280 4220 280	4670	1	1	@200
FB3 15#筋	Φ28	280 385 8775 套 280	610 9000	1	1	@200 总长9160
	Φ28	280 1160 7775 套 280	1385 8000	1	1	@200 总长8935
	Φ28	280 935 7775 套 280	1160 8000	1	1	@200 总长8710
	Φ28	280 8270 280	8720	1	1	@200
	Φ28	280 7820 280	8270	1	1	@200
	Φ28	280 7370 280	7820	1	1	@200
FB3 16#筋	Φ28	900 150° 2200 900	3970	3	3	@200

审核:

翻样: 秦黄海 13574434596 第 29 页,共35页 2017/2/19 星期日 9:57





钢筋配料表

料单编号:16102816

项目名称: 荆州一医地下室

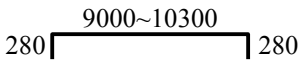
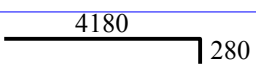
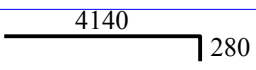
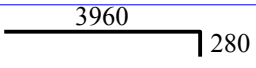
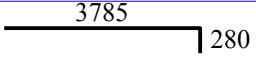
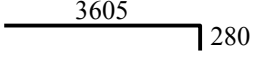
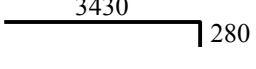
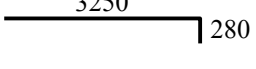
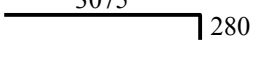
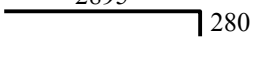
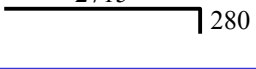
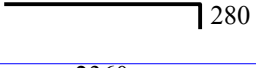
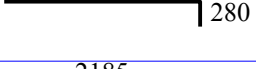
部位: 基础_塔楼A_承台

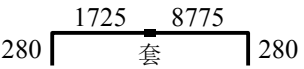
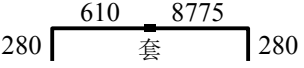
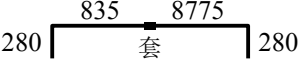
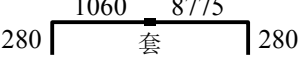
构件名称	级直 别径	钢筋简图	下料 (mm)	根件 数*数	总 根数	备 注	
	Φ28		4135	89	89	@200	
FB3 17#斜 坡水平分布 筋	Φ28		9448 ~10748	11	11	△130mm,@200	
FB3 18#筋	Φ28		4405	42	42	@200	
FB3 19#筋	Φ28		4365	1	1	@200	
	Φ28		4185	1	1	@200	
	Φ28		4010	1	1	@200	
	Φ28		3830	1	1	@200	
	Φ28		3650	1	1	@200	
	Φ28		3475	1	1	@200	
	Φ28		3295	1	1	@200	
	Φ28		3120	1	1	@200	
	Φ28		2940	1	1	@200	
	Φ28		2765	1	1	@200	
	Φ28		2585	1	1	@200	
	Φ28		2410	1	1	@200	
	FB3 20#筋	Φ28		1950 9000	7	7	@200 总长10500
	FB3 21#筋	Φ28		835 9000	1	1	@200 总长9385
Φ28			1060 9000	1	1	@200 总长9610	
Φ28			1285 9000	1	1	@200 总长9835	

审核:

翻样: 秦黄海 13574434596 第 30 页,共35页 2017/2/19 星期日 9:57



钢筋配料表

料单编号:16102816

项目名称: 荆州一医地下室

部位: 基础_塔楼A_承台

构件名称	级直别径	钢筋简图	下料 (mm)	根件 数*数	总 根数	备 注
	Φ28	280 280	1510 9000	1	1	@200 总长10060
	Φ28	280 280	1735 9000	1	1	@200 总长10285
FB3 22#筋	Φ28	280 280	1110 8050	1	1	@200 总长8710
	Φ28	280 280	1385 8000	1	1	@200 总长8935
	Φ28	280 280	610 9000	1	1	@200 总长9160
	Φ28	280 280	8935	1	1	@200
	Φ28	280 280	8710	1	1	@200
FB3 23#筋	Φ28	280 2250	7435	1	1	@200
	Φ28	280 2250	7255	1	1	@200
	Φ28	280 2250	7075	1	1	@200
	Φ28	280 2250	6900	1	1	@200
	Φ28	280 2250	6775	1	1	@200
FB3 24#筋	Φ28	280 2250	8320	1	1	@200
	Φ28	280 2250	8145	1	1	@200
	Φ28	280 2250	7965	1	1	@200
	Φ28	280 2250	7790	1	1	@200
	Φ28	280 2250	7610	1	1	@200
FB3 25#筋	Φ28	280 2250	1210 8000	1	1	@200 总长6793
	Φ28	280 2250	9035	1	1	@200
	Φ28	280 2250	8855	1	1	@200

审核:

翻样: 秦黄海 13574434596 第 31 页,共35页 2017/2/19 星期日 9:57







钢筋配料表

料单编号:16102816

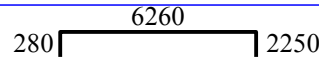
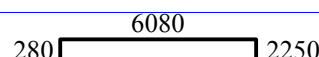
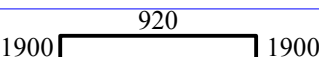
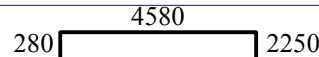
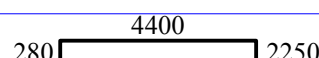
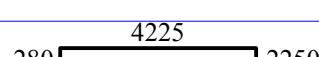
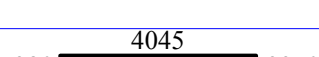
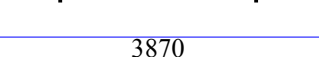
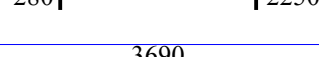
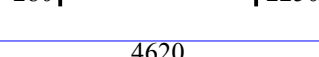
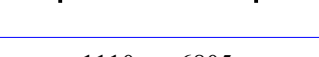
项目名称: 荆州一医地下室

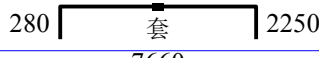
部位: 基础_塔楼A_承台

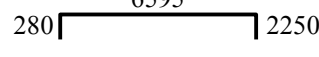
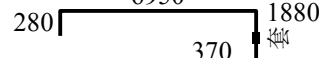
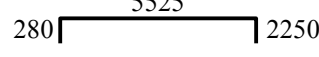
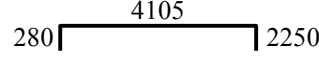
构件名称	级直别径	钢筋简图	下料 (mm)	根件 数*数	总 根数	备 注
	Φ28	280  2250	8675	1	1	@200
	Φ28	280  2250	8500	1	1	@200
FB3 26#筋	Φ18	1900  1900	4650	24	24	@200
FB3 27#筋	Φ28	280  2250	6995	1	1	@200
	Φ28	280  2250	6820	1	1	@200
	Φ28	280  2250	6640	1	1	@200
	Φ28	280  2250	6465	1	1	@200
	Φ28	280  2250	6285	1	1	@200
	Φ28	280  2250	6110	1	1	@200
FB3 28#筋	Φ28	280  2250	7040	18	18	@200
FB3 29#筋	Φ28	280  2250	1335 9000	1	1	@200 总长7920
	Φ28	280  2250	9430 910	2	2	@200
FB3 30#筋	Φ28	280  2250	1800 7925	1	1	@200 总长7305
	Φ28	280  2250	9000 1080	1	1	@200
	Φ28	280  2250	8655	1	1	@200
	Φ28	280  2250	9010	1	1	@200
	Φ28	280  2250	9000 370	1	1	@200
FB3 31#筋	Φ28	280  2250	7945	1	1	@200
	Φ28	280  2250	6525	1	1	@200
	Φ28	280  2250	7590	1	1	@200

审核:

翻样: 秦黄海 13574434596 第 32 页,共35页 2017/2/19 星期日 9:57



钢筋配料表

料单编号:16102816

项目名称: 荆州一医地下室

部位: 基础_塔楼A_承台

构件名称	级直别径	钢筋简图	下料 (mm)	根件 数*数	总 根数	备 注
	Φ28	280 2250	6880	1	1	@200
	Φ28	280 2250	8300	1	1	@200
	Φ28	280 2250	7235	1	1	@200
FB3 32#筋	Φ28	280 280	6510	1	1	@200
	Φ28	280 280	6060	1	1	@200
	Φ28	280 280	5610	1	1	@200
	Φ28	280 280	5160	1	1	@200
	Φ28	280 280	4710	1	1	@200
FB3 33#筋	Φ28	280 280	8760	1	1	@200
	Φ28	280 280	8310	1	1	@200
	Φ28	280 280	7860	1	1	@200
	Φ28	280 280	7410	1	1	@200
	Φ28	280 280	6960	1	1	@200
FB3 34#筋	Φ28	280 280	1775 9000	1	1	@200 总长10325
	Φ28	280 280	1550 9000	1	1	@200 总长10100
	Φ28	280 280	9000 1325	1	1	@200 总长9875
	Φ28	280 280	9000 1100	1	1	@200 总长9650
	Φ28	280 280	9000 875	1	1	@200 总长9425
	Φ28	280 280	8000 1650	1	1	@200 总长9200
	Φ28	280 280	8000 1425	1	1	@200 总长8975

审核:

翻样: 秦黄海 13574434596 第 33 页,共35页 2017/2/19 星期日 9:57



钢筋配料表

料单编号:16102816

项目名称: 荆州一医地下室

部位: 基础_塔楼A_承台

构件名称	级直别径	钢筋简图	下料 (mm)	根件 数*数	总 根数	备 注
	Φ28		8000 1200	1	1	@200 总长8750
FB3 35#筋	Φ28		1990 9000	6	6	@200 总长10540
FB3 36#筋	Φ18		6650	11	11	@200
FB3 37#筋	Φ18		6450	6	6	@200
FB3 38#筋	Φ18		6345	1	1	@200
	Φ18		5445	1	1	@200
	Φ18		6120	1	1	@200
	Φ18		5670	1	1	@200
	Φ18		5895	1	1	@200
FB3 39#筋	Φ18		3010 9000	1	1	@200 总长8280
	Φ18		3155 9000	1	1	@200 总长8426
	Φ18		3345 9000	1	1	@200 总长8618
	Φ18		3570 9000	1	1	@200 总长8843
	Φ18		3795 9000	1	1	@200 总长9068
	Φ18		4020 9000	1	1	@200 总长9293
	Φ25		4120	72	72	马镫每平方1个
	Φ25		1800	144	144	斜向支撑每个马镫2个
以下为FB3封边钢筋						
	Φ18		4050	35	35	封边竖向。@200用于深处
	Φ18		3045	77	77	封边竖向。@200用于深处

审核:

翻样: 秦黄海 13574434596 第 34 页,共35页 2017/2/19 星期日 9:57





钢筋配料表

料单编号:16102816

项目名称: 荆州一医地下室

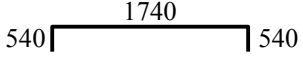
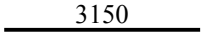
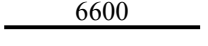
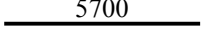
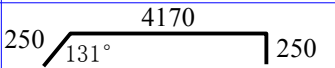
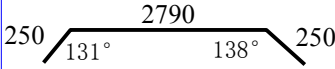
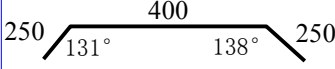
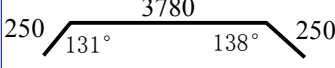
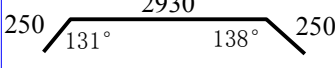
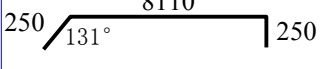
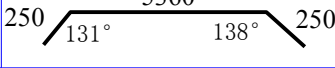
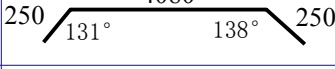
部位: 基础_塔楼A_承台

构件名称	级直 别径	钢筋简图	下料 (mm)	根件 数*数	总 根数	备 注
	Φ18		2750	45	45	封边竖向。@200
40#水平分 布筋	Φ12		3150	6*2	12	@200
41#水平分 布筋	Φ28		6600	6	6	@200
	Φ12		5700	6	6	@200
42#水平分 布筋	Φ12		4640	14	14	@200
43#水平分 布筋	Φ12		3280	6	6	@200
44#水平分 布筋	Φ12		890	6	6	@200
45#水平分 布筋	Φ12		4270	14	14	@200
46#水平分 布筋	Φ12		3420	14	14	@200
47#水平分 布筋	Φ12		8580	14	14	@200
48#水平分 布筋	Φ12		5850	14	14	@200
49#水平分 布筋	Φ12		4570	8	8	@200
50#水平分 布筋	Φ12		3420	8	8	@200

审核:

翻样: 秦黄海 13574434596 第 35 页,共35页 2017/2/19 星期日 9:57